



**Guardian**  
Warm Roof



**Conservatory warm roof  
conversion system**



## IS YOUR EXISTING CONSERVATORY ROOF:

- Too hot in summer or too cold in winter?
- Waste of valuable living space?
- Unable to relax to watch TV?



# Transform your conservatory into a comfortable, all year round living space...



## ...WITH THE GUARDIAN WARM ROOF CONVERSION SYSTEM:

- High performance insulated warm roof conversion system
- Lightweight aluminium frame
- Provides energy cost savings
- Reduces rain noise and glare

The Guardian Warm Roof System is the biggest revelation to hit the home improvement market in the last ten years. You can now change your old conservatory roof for a new Guardian Roof and effectively turn your old conservatory into a new extension that can be used all year round. The complete changeover takes only three days with very minimal disruption to your household.

The Roof System is designed to replace the existing glass or polycarb roof of a conservatory while retaining the original windows, doors, frames and walls. At the same time providing substantial energy cost savings.

Fully tested and approved to all thermal and structural standards, the Guardian system is a high performance insulated roof system comprising of a pre-engineered lightweight frame, two layers of rigid insulation board, internal insulated plasterboard, exterior grade plywood, vapour membrane and a choice of external tile finishes.



### Guardian warm roof construction

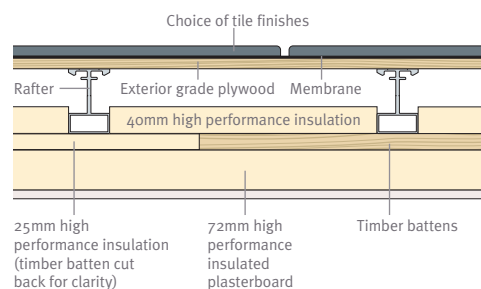



With planning consent, **internal dividing doors or walls can be removed** to provide a permanent extension to your living room, kitchen, etc.

## THE AFFORDABLE GUARDIAN WARM ROOF CONVERSION SYSTEM



**LABC Registered (minimise building control checks & approval process)**



Reduced fuel bills for the life of the roof



Comfortable ambient temperature all year round



A wide range of roof colours and finishes available



Achieves a U-value of 0.18 (England & Wales) and 0.15 (Scotland)



Thermal, structural and condensation risk tested



Fast installation utilising existing walls, windows and doors via our **nationwide installer network**



Fully guaranteed

  
**Guardian**  
Warm Roof

[www.guardianroof.co.uk](http://www.guardianroof.co.uk)

# Roof design options

Guardian roof provide standard warm roof solutions for existing conservatory roof design. Bespoke solutions also available.

## Edwardian

The Classic Sunroom shape. Together with attractive roof windows the Edwardian Guardian Roof is the traditional safe bet for styling and convenience. The Edwardian shape also helps to maximise the room space below. The roof is very sympathetic to all house styles as its ridge is so versatile, it can also be the perfect solution to a Bungalow extension.

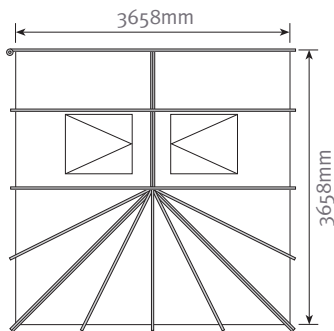
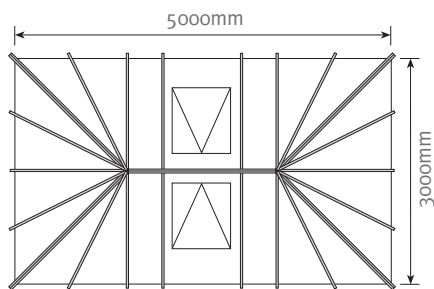

## Lean-to

The Guardian Lean-To is ideal to maximise space at the back of the house. The ends can either have one or two hips (slopes). It is ideal for kitchen extensions and can go as low as 15 Degrees with roof windows.

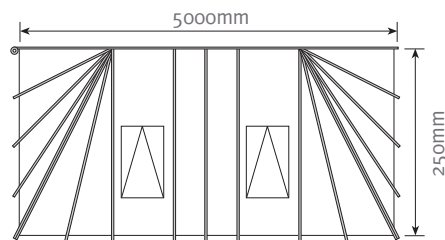
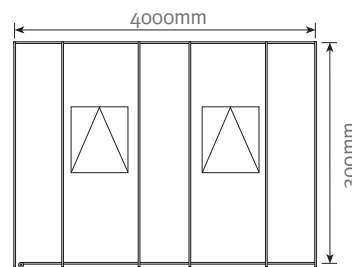

## Victorian

The Victorian roof can also work really well when you might not have as much space in the garden as you would like. The internal plaster finish on the roof can look really attractive with its facet front finish.

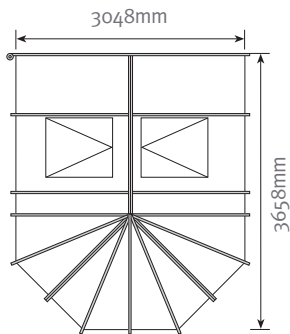

## Gable ended

The gable ended main feature is its continuous height it brings to the room owing to its long ridge down the centre. The gable also allows you to get the most from your roof windows giving you a light and airy space. Suitable for replacement or new build.

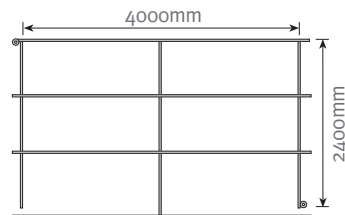

## Combination

Increase your options with a combination Guardian Sunroom. A P-Shape simply combines the benefits of two different styles to maximise your living environment. The combination can also come in what you call a T-shape.

As individual as you are.

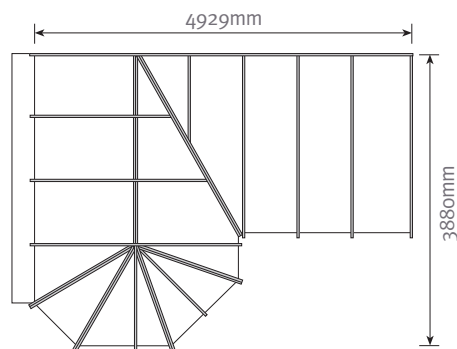

# What you need to know

The Guardian Warm Roof Conversion System has been designed to provide a high performance thermal and structural solution with zero condensation risk over the life of the roof.

Each of these elements has been fully tested and approved by independent industry experts to evaluate thermal performance, structural performance, condensation risk and quantify energy savings.

The Guardian roof best practice approach has enabled the Local Authority Building Control (LABC) to certify the Guardian Roof System as a LABC Registered System.

In some cases the Guardian roof conversion would be exempt if it was at ground level, does not exceed 30m<sup>2</sup> floor area, be thermally separated from the building it is attached to, have an independent heating system from the main building and have glazing that meets Part N in the critical zones.

However, Building Control approval should always be sought. But, with Guardian systems being LABC certified, this process should proceed without complication.

The Guardian Warm Roof Conversion System is fully compliant for use in a conventional situation such as an extension and has been fully approved by LABC for use as a full replacement conservatory roof.

With Building Control approval, Guardian high performance insulated roof conversions may allow the removal of the wall between the house and the conservatory, offering the flexibility to extend and enlarge an existing kitchen, living room or bedroom.

Please consult your installer for more details.

## LABC approval



## The Guardian Service Package

Building work of any kind can be a daunting process. The Guardian team will manage the roof conversion you want. We will manage your project through a seamless process from your original enquiry, through planning and building control approval.



5 Weeks

### Aecom energy saving study



AECOM modelled a typical house with a standard “Victorian 12’ x 12” conservatory.

The conservatory was northward projecting with an electric heating system. A future energy price forecasts was accounted for under the “Green Stimulus” price forecast that yielded a saving of £5,447 after 25 years.

The key conclusion drawn from this evaluation is that the greatest benefits from installing the “Guardian” roof are made when it is retrofitted, as a result of the greater difference between the U-values of the original roof and the new roof type.

Any of the above reports are available on request from Guardian Warm Roofs, please email: [info@guardianroof.co.uk](mailto:info@guardianroof.co.uk)

### Structural analysis



### Kingspan thermal analysis



### Kingspan Insulation condensation risk analysis

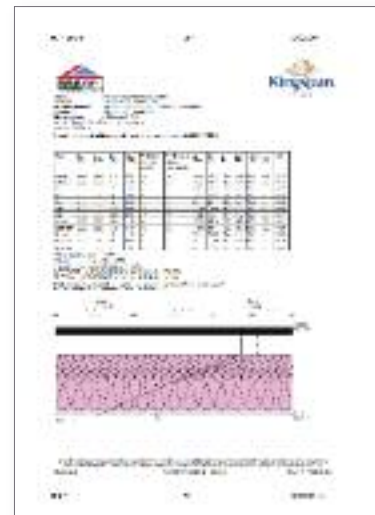

Guardian Service Package is the hassle-free way to achieve and keep you informed at every stage, providing a planning permission to final installation and certification.

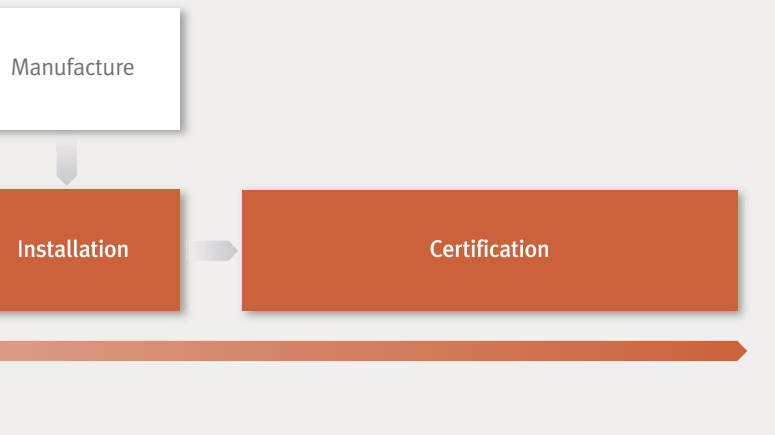

# Transform your living environment in twelve simple steps



Remove existing glass roof.  
Replace with Guardian warm  
roof ring beam.



Fix box gutter to existing wall



Fix ringbeam to existing windows



Fix rafters to ringbeam



Install external insulation



Edwardian conservatory

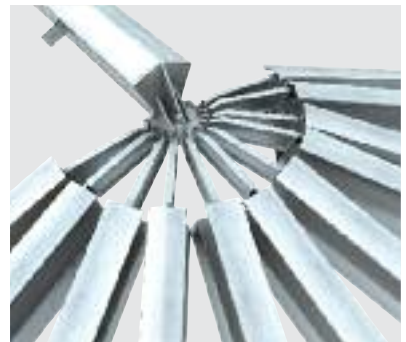

Victorian conservatory option



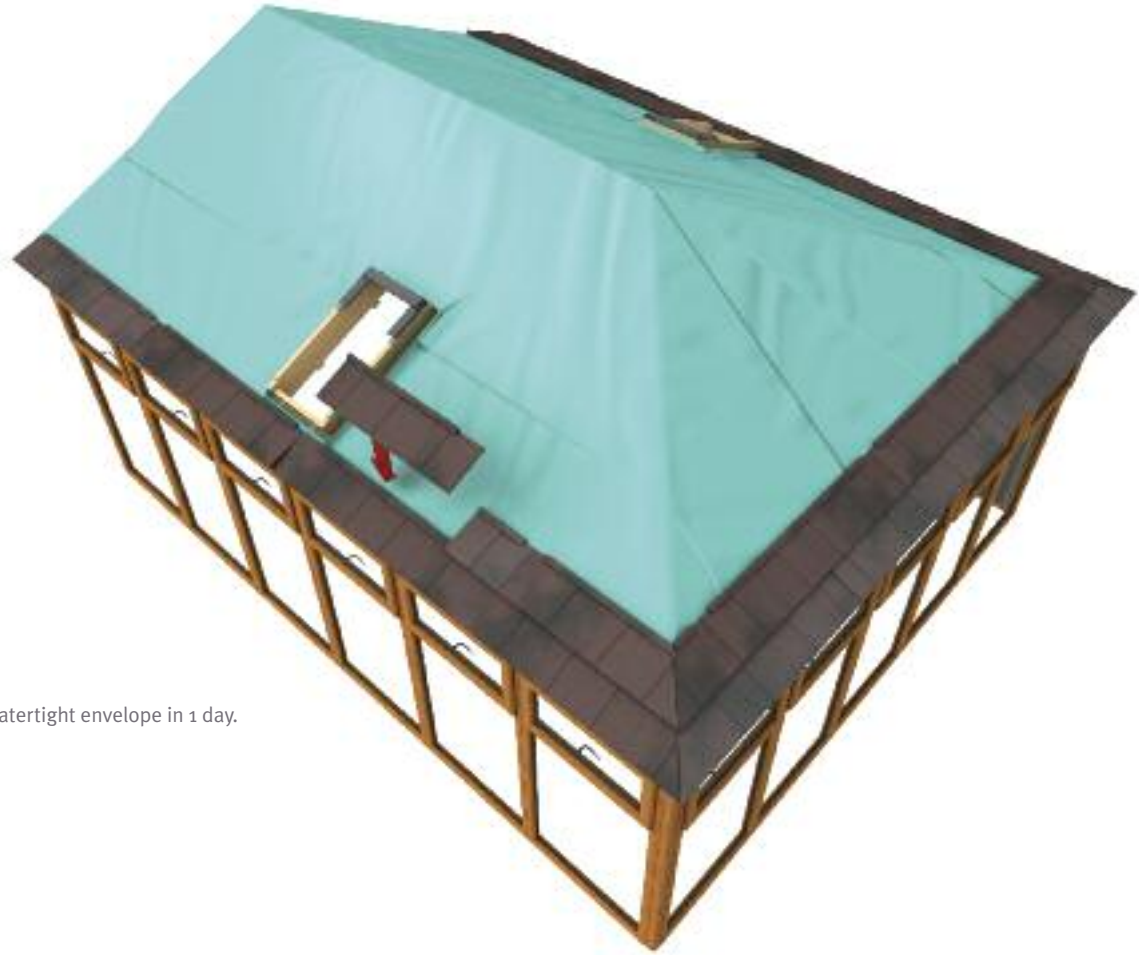

Watertight envelope in 1 day.



Install roof window frame

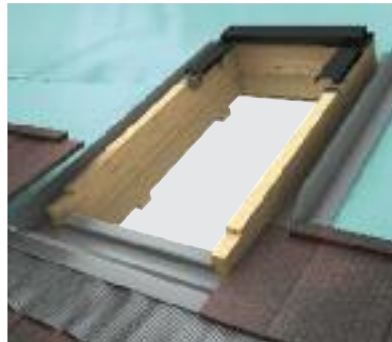

Install roof window



Fix rafter cap and ridge



Install insulation between batten



Fit gutter



Plaster ceiling

  
**Guardian**  
Warm Roof

[www.guardianroof.co.uk](http://www.guardianroof.co.uk)

# Gallery

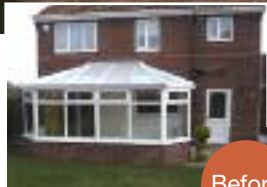



  
**Guardian**  
Warm Roof

[www.guardianroof.co.uk](http://www.guardianroof.co.uk)



Guardian Roofs

FREE Phone: 0800 0665832 Email: [info@guardianroof.co.uk](mailto:info@guardianroof.co.uk)

[www.guardianroof.co.uk](http://www.guardianroof.co.uk)